









 Ø6,3x50 mm A1 x 42	 Ø12 mm A2 x 42	 4 mm A3 x 1	 Ø15x12 mm B1 x 14	 Ø5x44 mm B2 x 14
 Ø20 mm B3 x 14	 Ø4x16 mm D1 x 56	 Ø3x25 mm D2 x 7	 Ø1,6x25 mm F x 136	 Ø8x36 mm G x 39
 K x 4	 Ø5x16 mm L x 8	 M x 2	 N x 5	 Z x 7

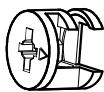
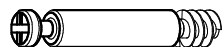

Box 1/2

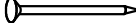
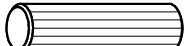
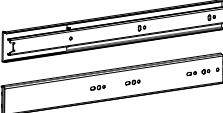
873x396x3 mm

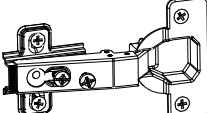
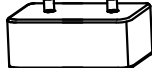

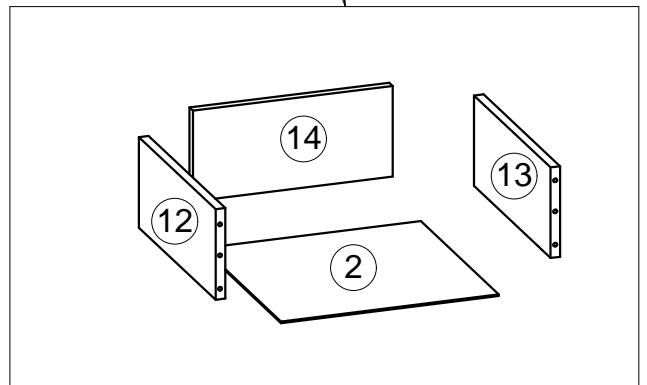
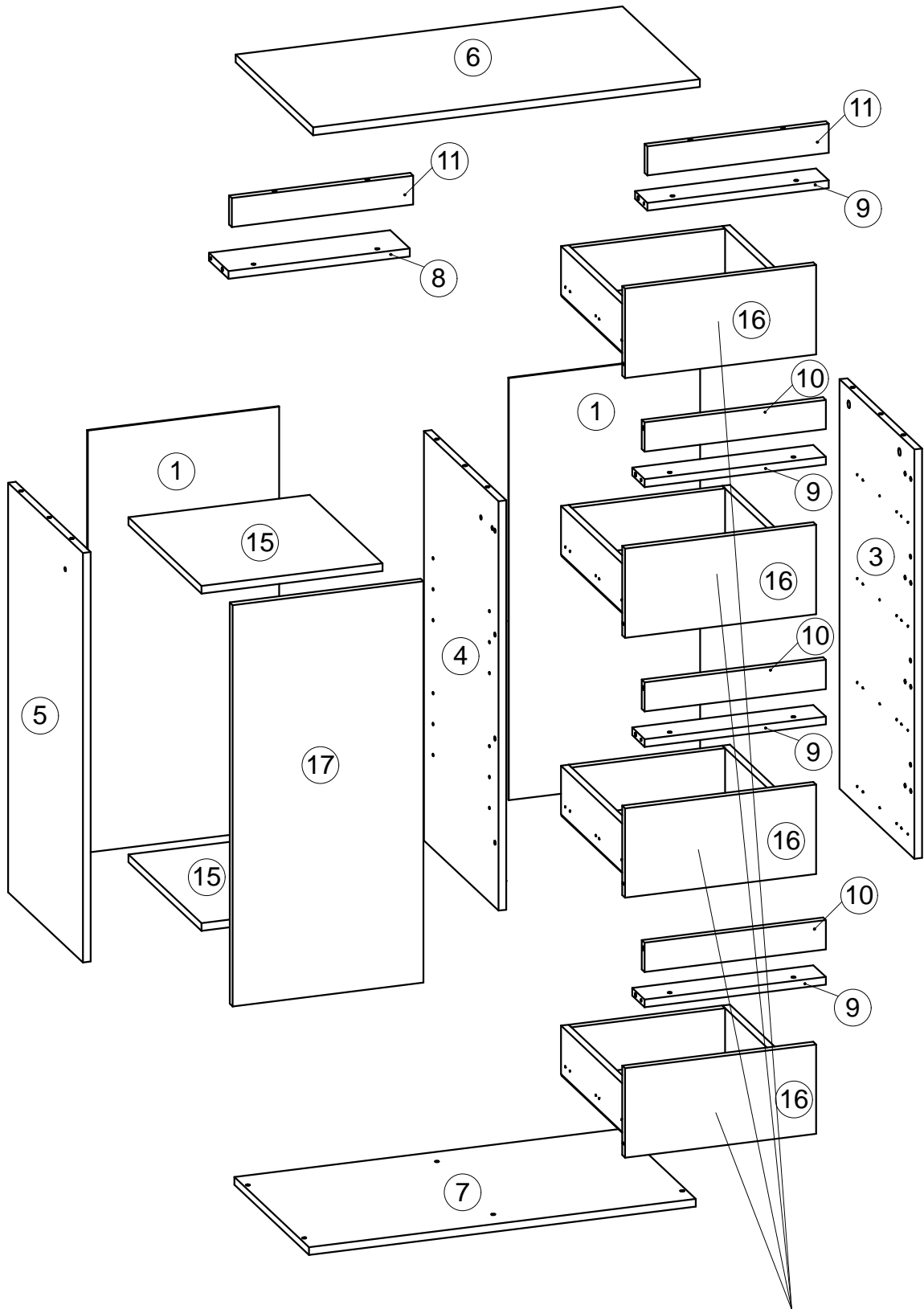
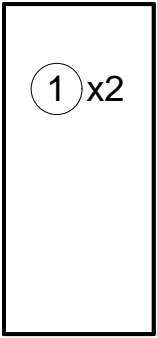
406x348x3 mm

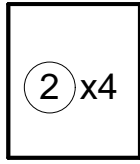

799x440x16 mm

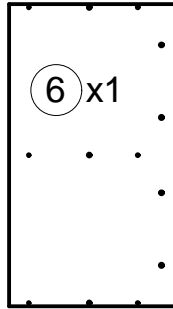

799x424x16 mm

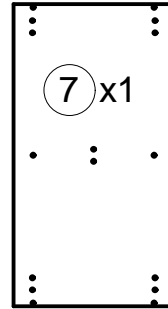

375x110x16 mm

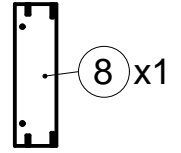

Fittings & Tools

375x70x16 mm

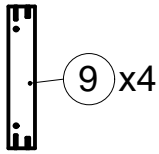

375x60x16 mm

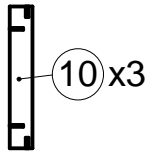

375x60x16 mm

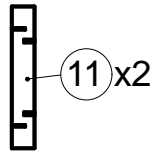

400x100x16 mm

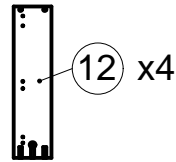

400x100x16 mm

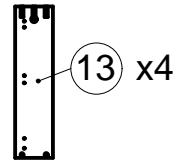

318x100x16 mm

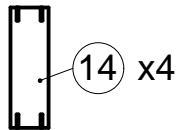

414x375x16 mm

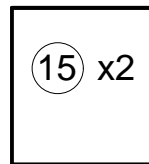

Box 2/2

847x424x16 mm

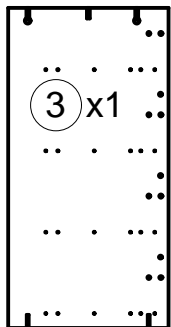

847x424x16 mm

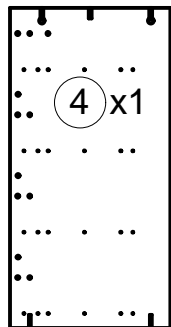

847x424x16 mm

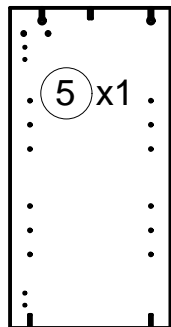

394x184x16 mm

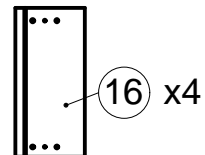

394x829x16 mm

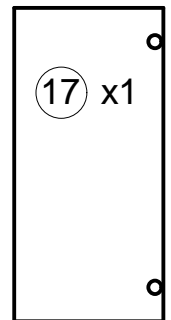

1



B1 x 2



G x 7

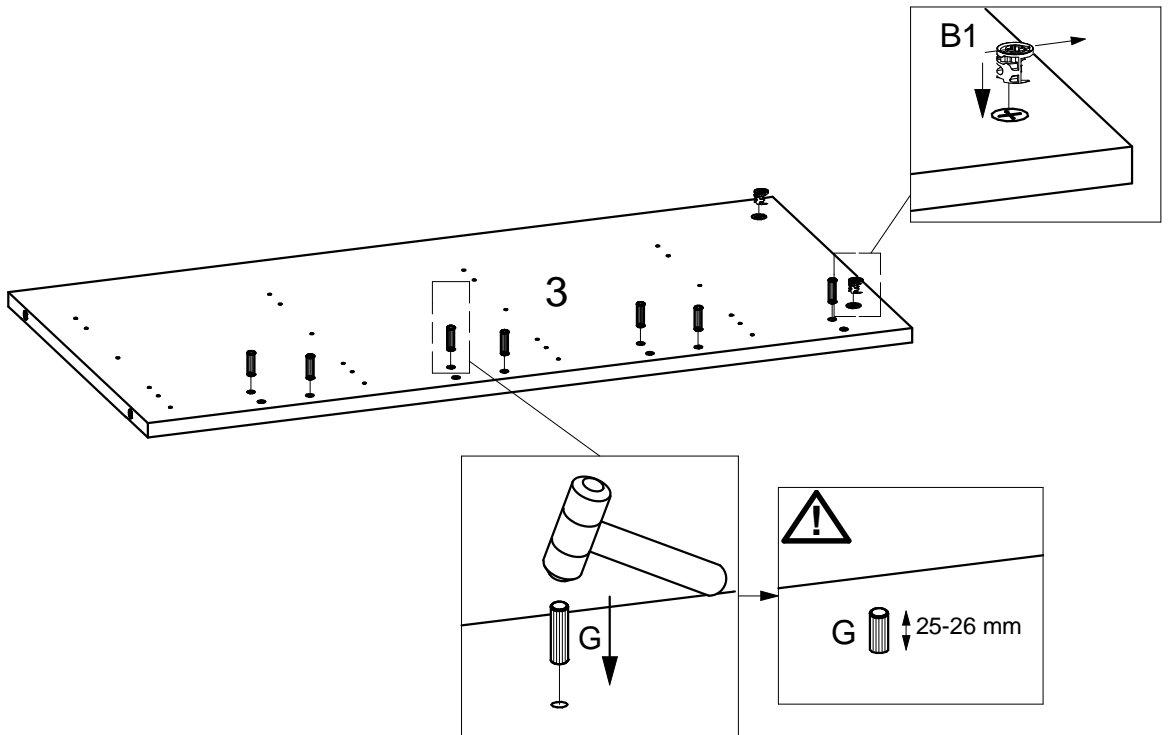
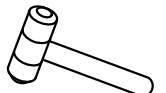
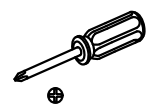

2



G x 1



L x 4

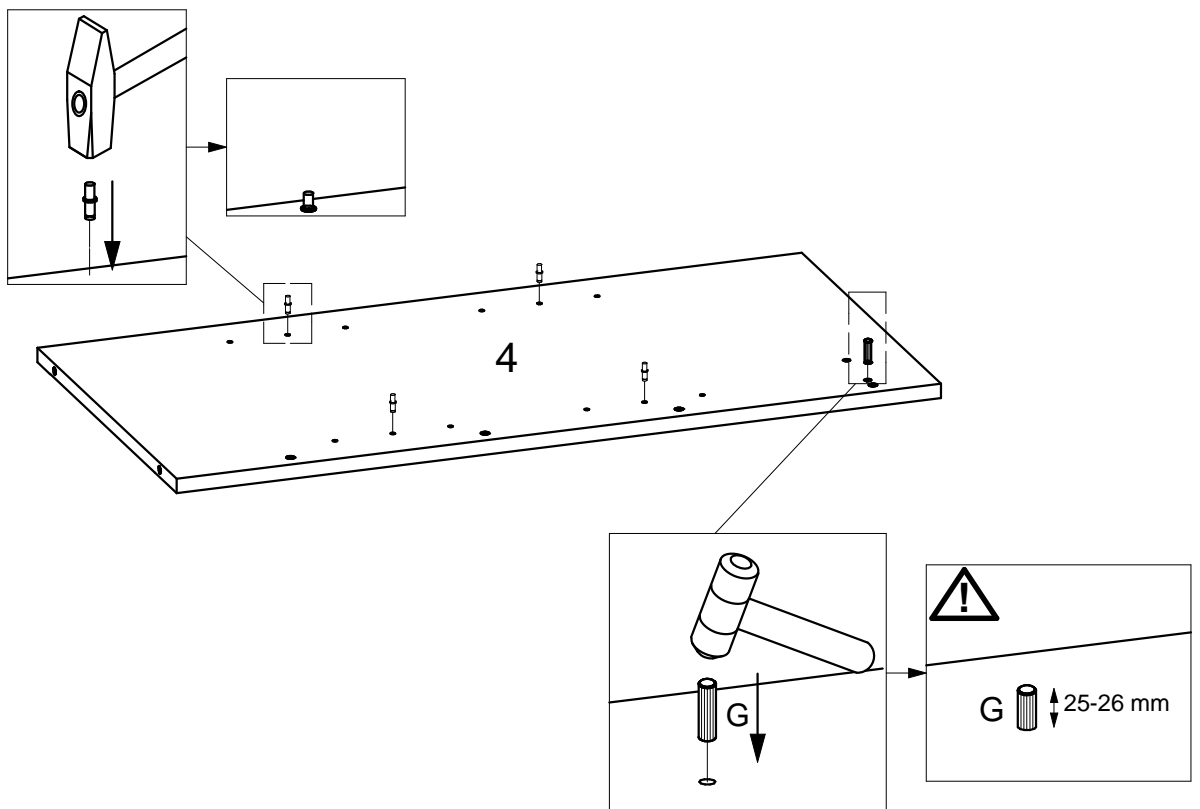
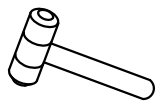
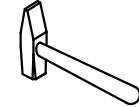

3



B1 x 2



G x 7

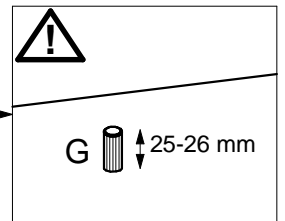
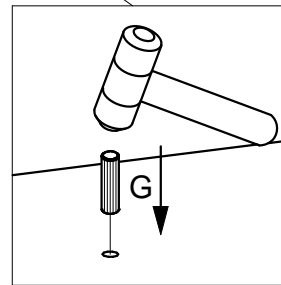
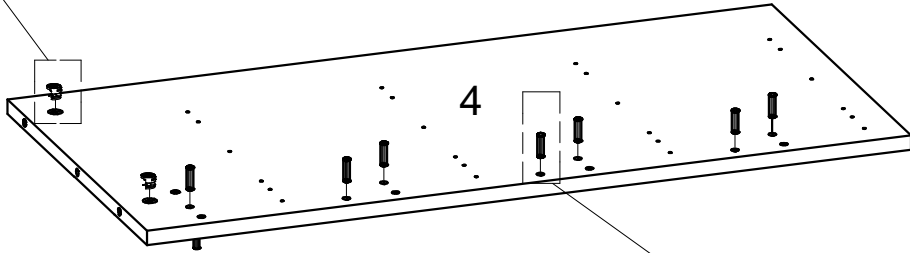
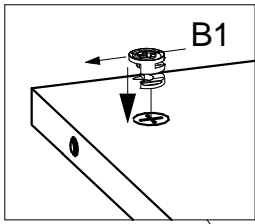
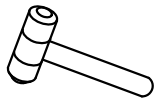
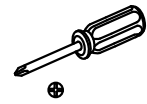

4



B1 x 2



D1 x 4



G x 1



L x 4



M.1 x 2

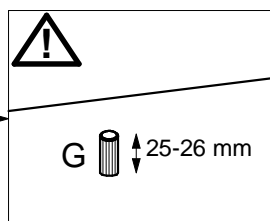
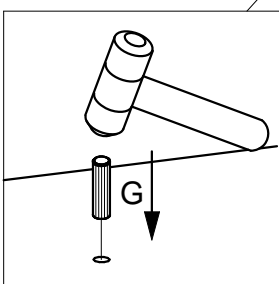
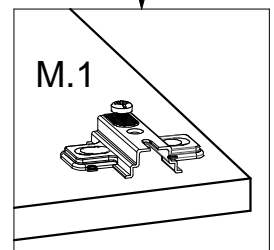
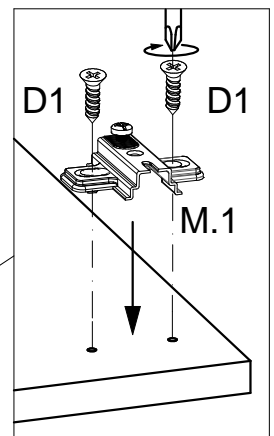
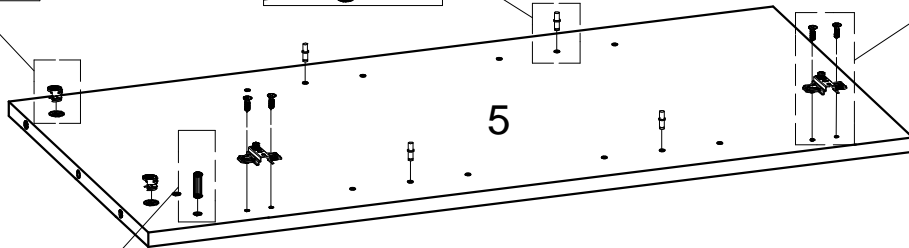
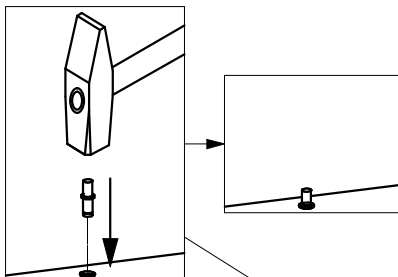
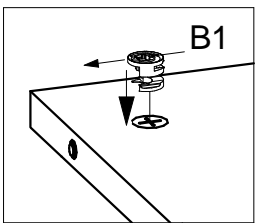
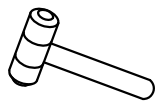
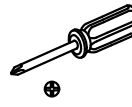
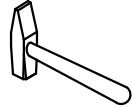

5

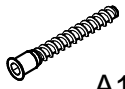

A1 x 4



A2 x 4



A3 x 1

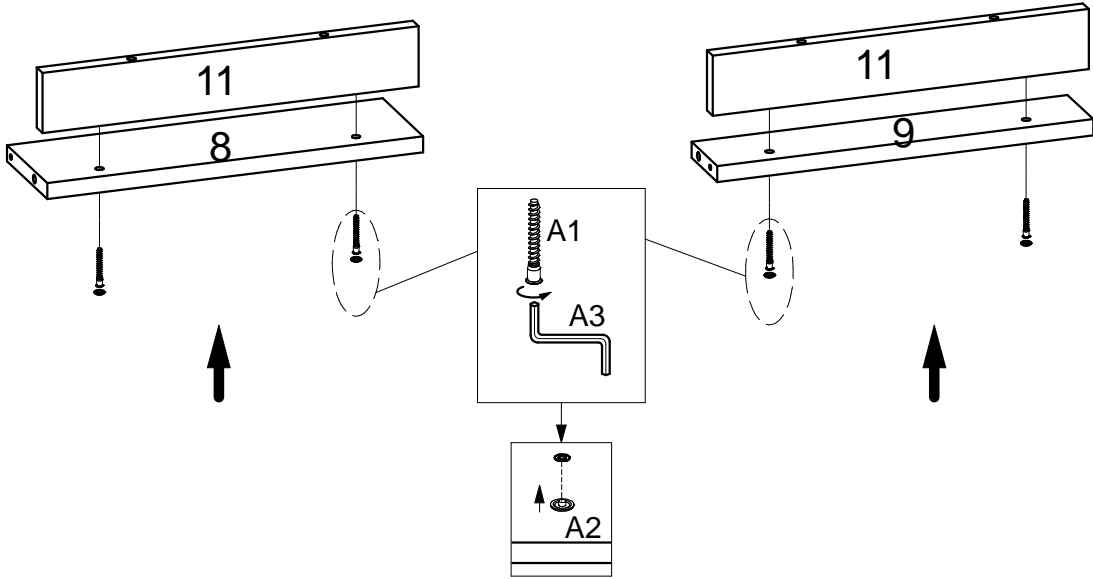

6

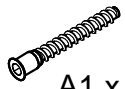

A1 x 6



A2 x 6



A3 x 1

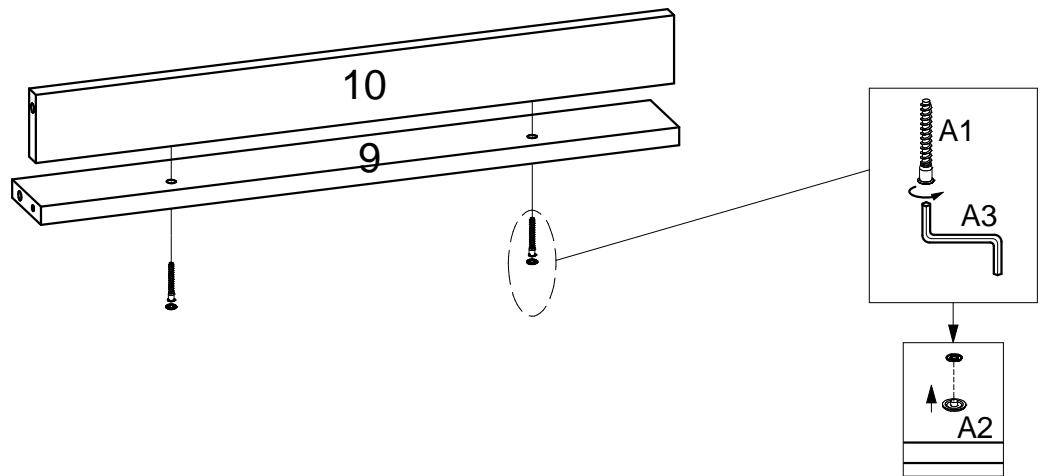

x 3

7

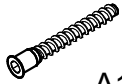

A1 x 8



A2 x 8



A3 x 1

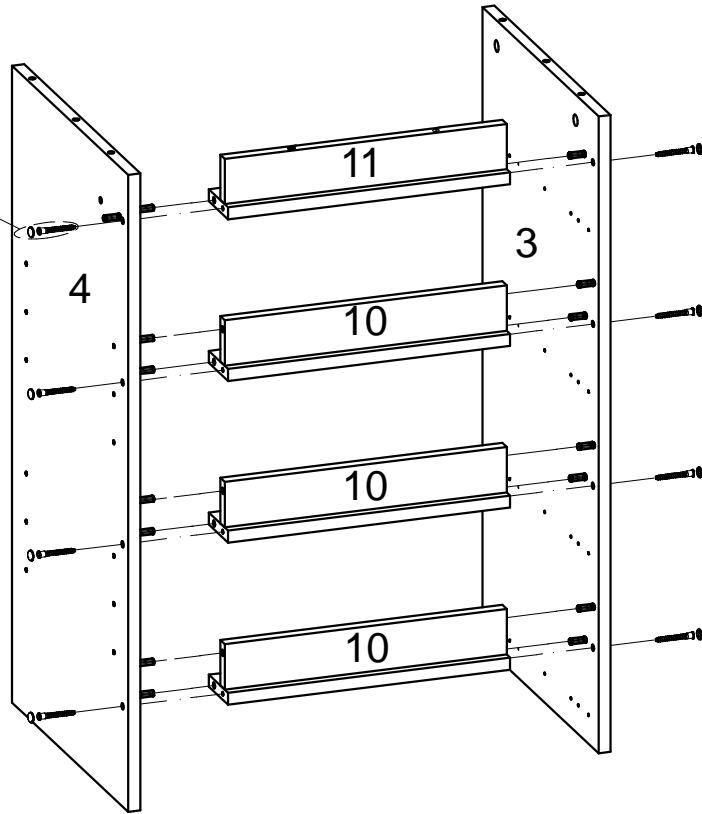
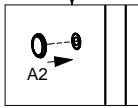
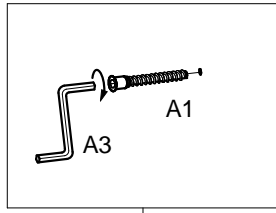
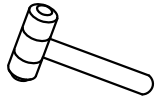

8



A1 x 2



A2 x 2



A3 x 1

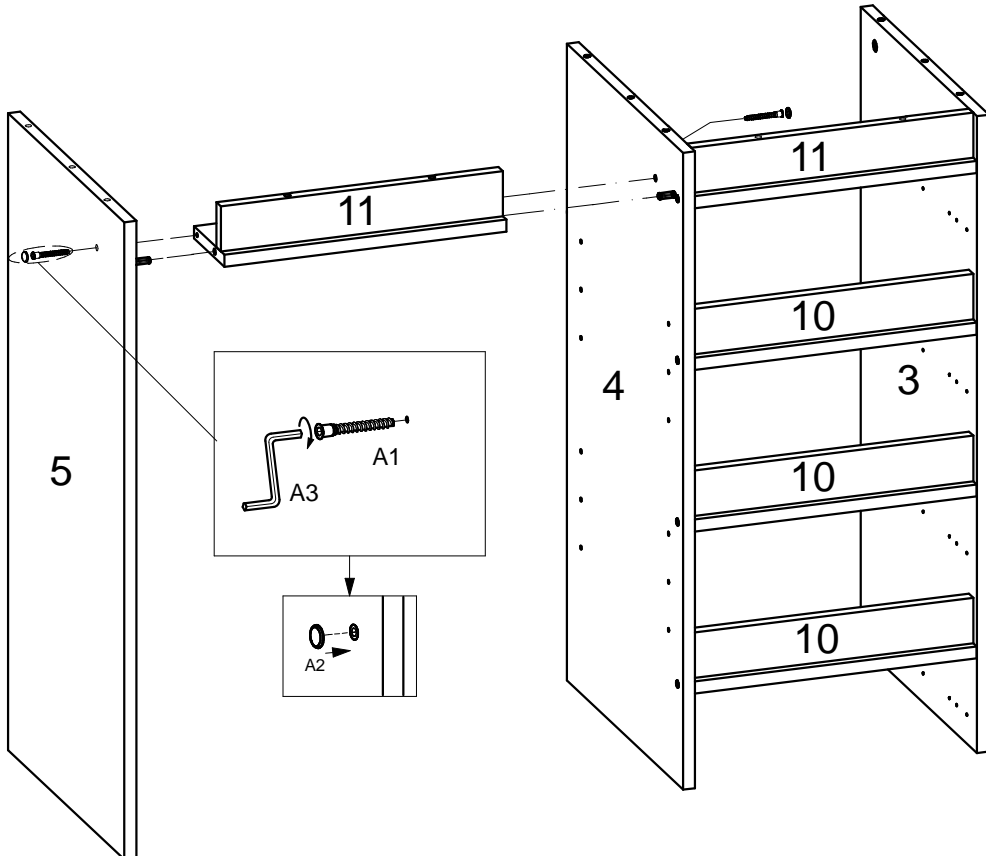
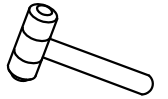

9

B2 x 6

G x 7

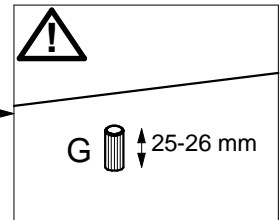
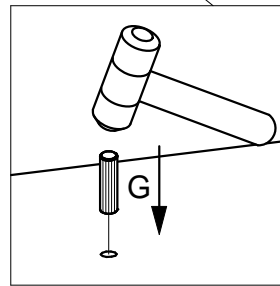
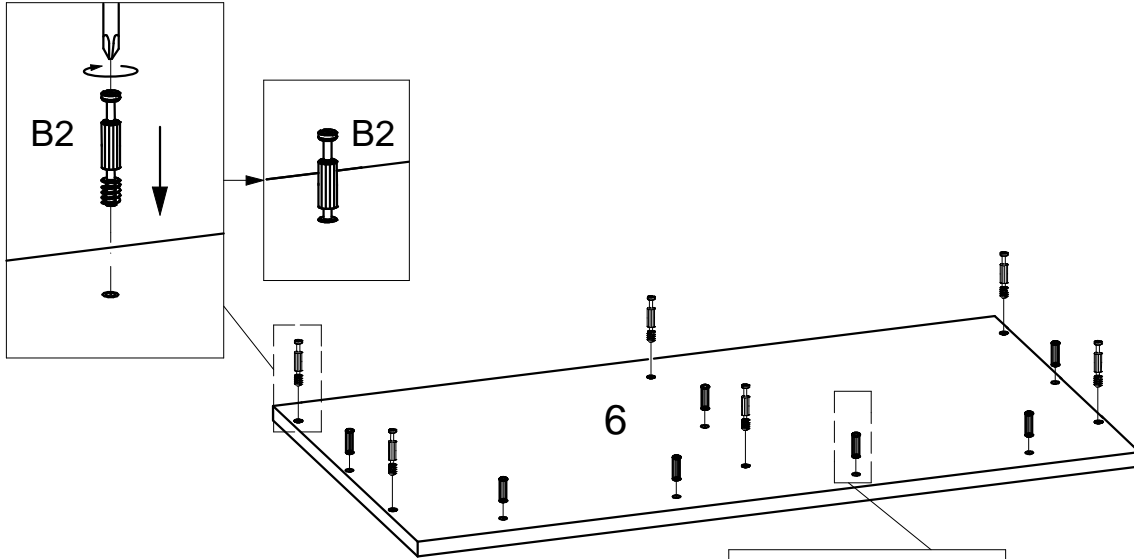
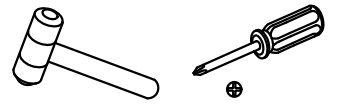

10

A1 x 6

A2 x 6

A3 x 1

B3 x 6

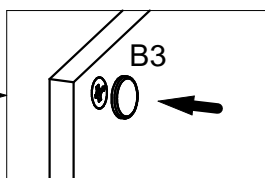
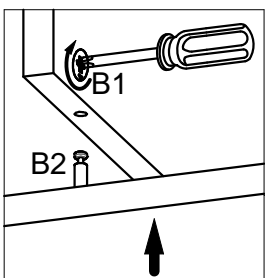
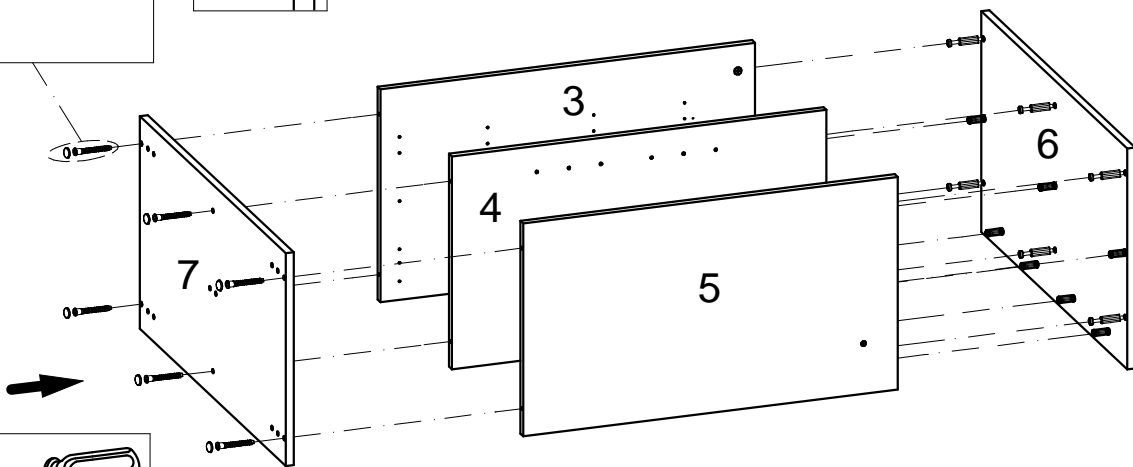
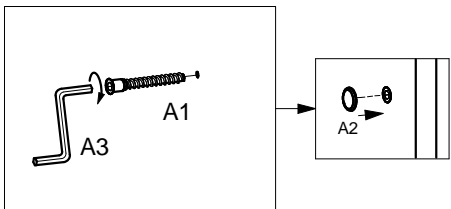
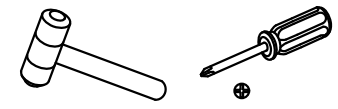

11



D2 x 7

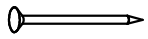

F x 48

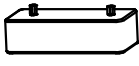

N x 5



Z x 7

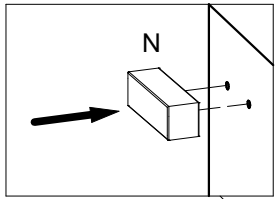
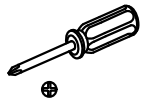
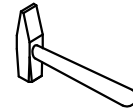

⚠ XX=YY≅90°

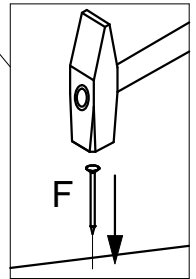
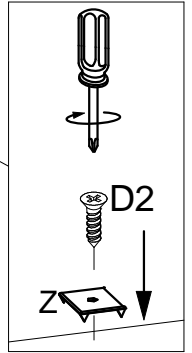
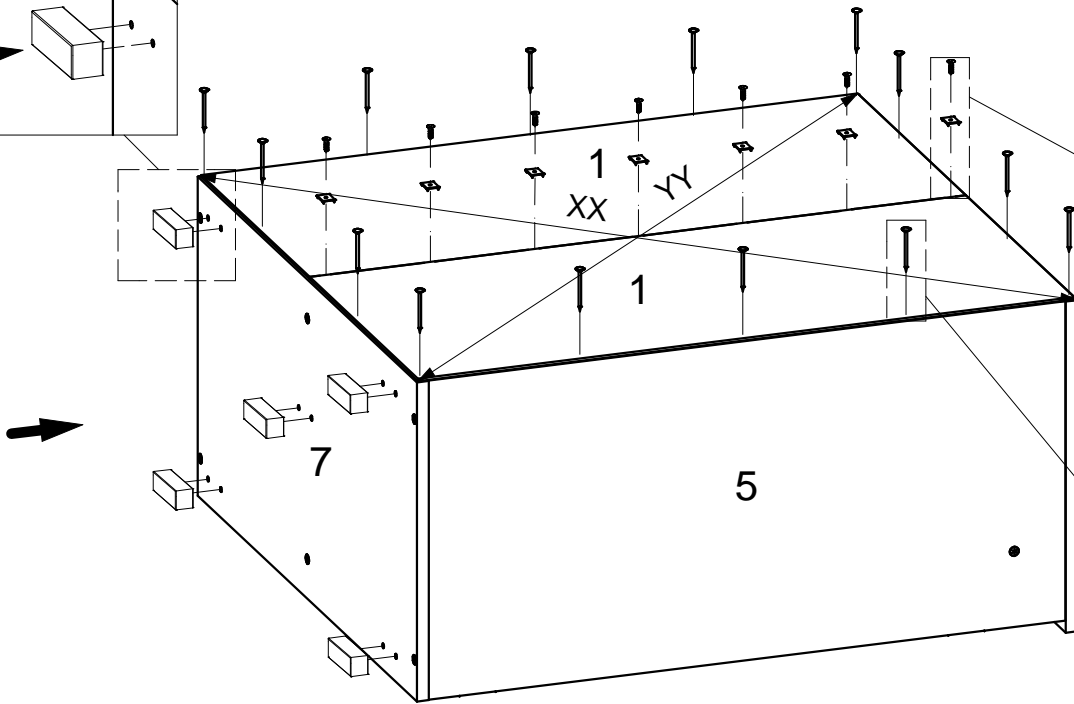

12



D1 x 24



K.1 x 4



K.2 x 4

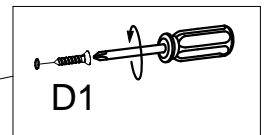
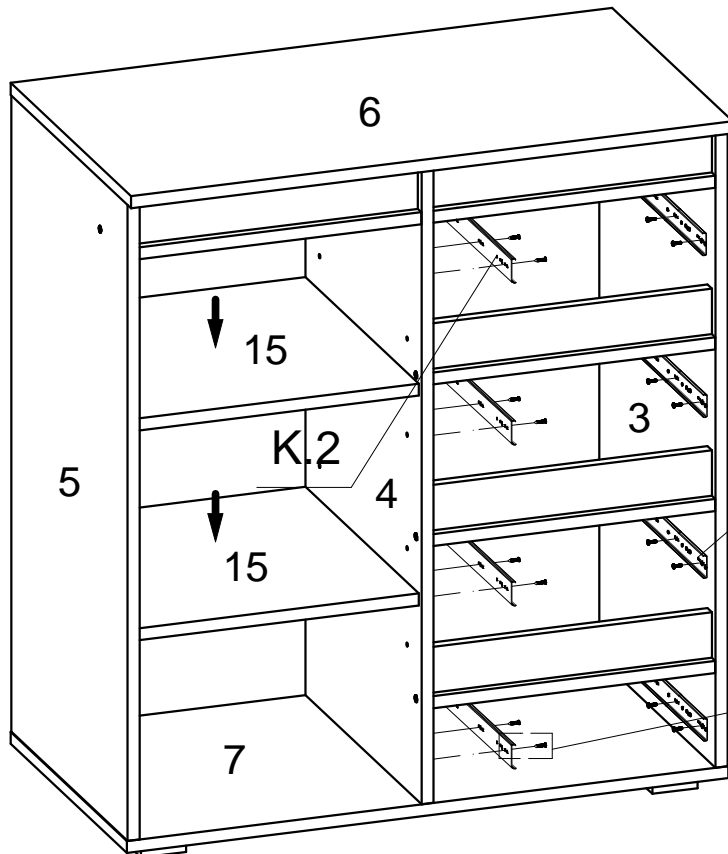
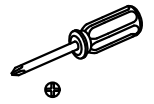

13

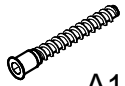

A1 x 16



A2 x 16



A3 x 1



B1 x 8

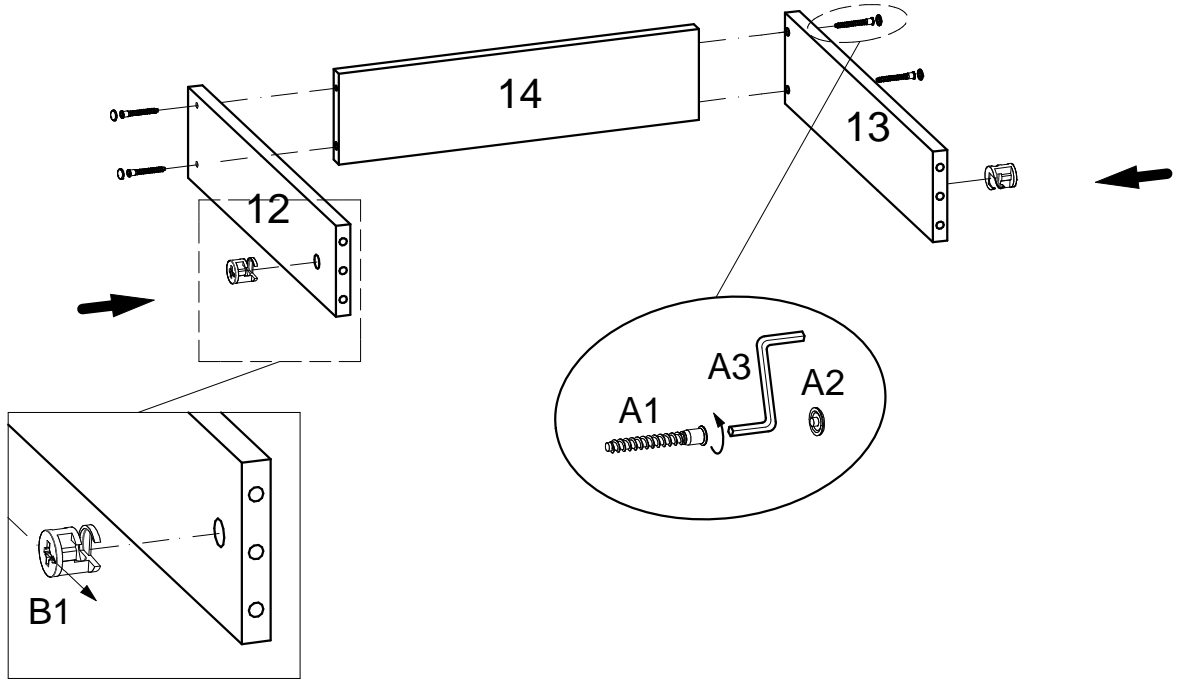

x 4

14



B2 x 8



B3 x 8



G x 16

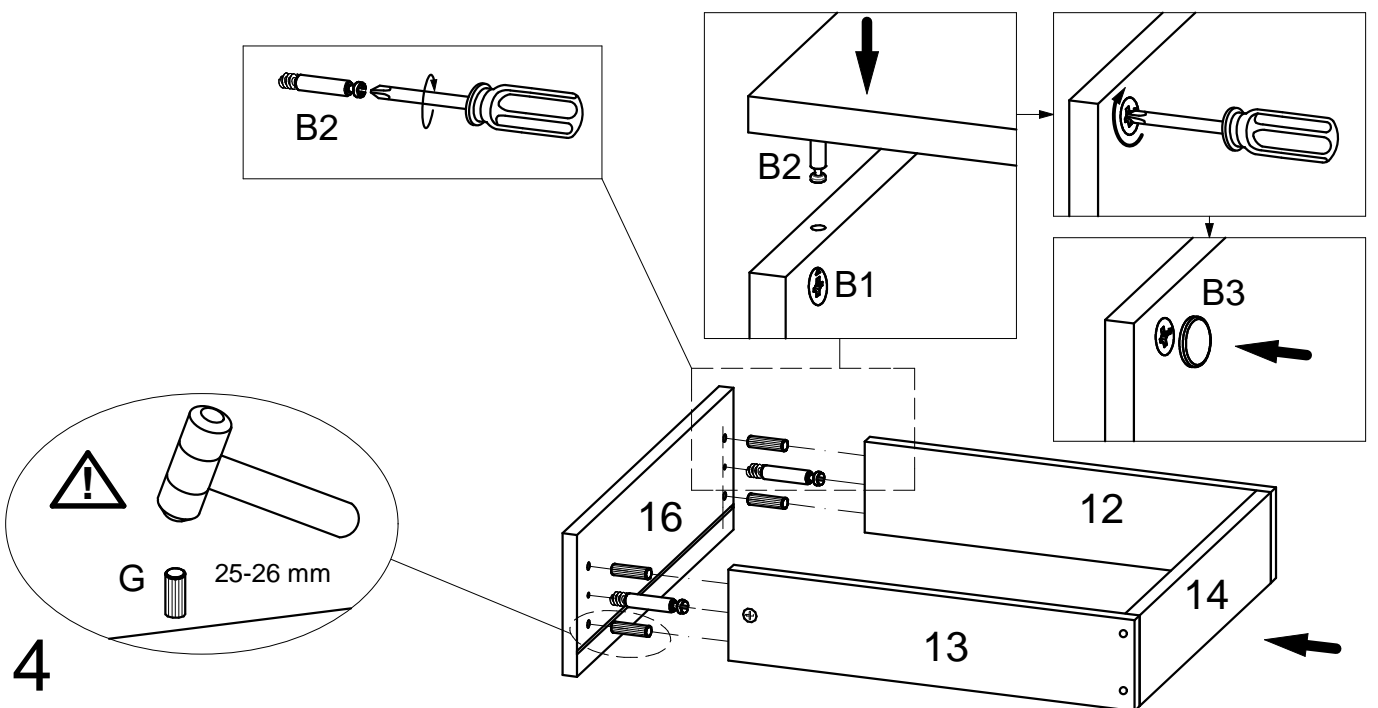
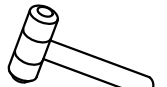
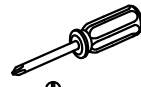

x 4

15

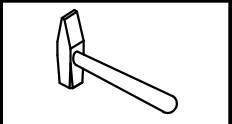
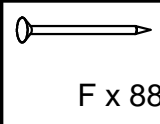

⚠ XX=YY≅90°

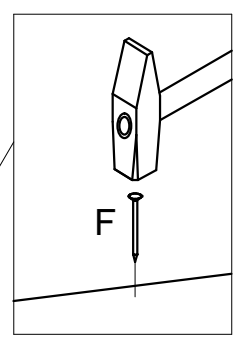
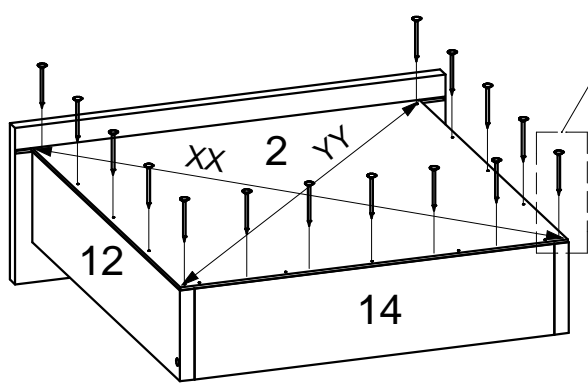

x 4

16

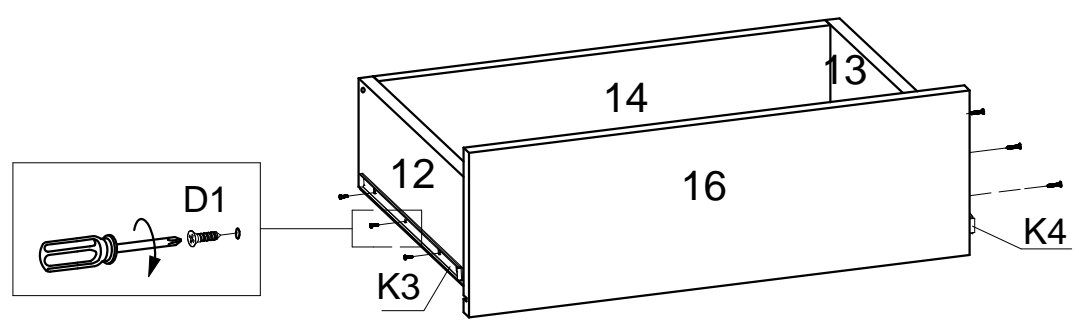
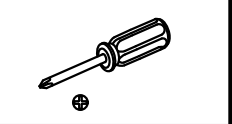
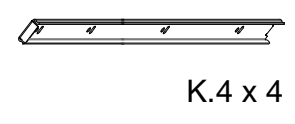
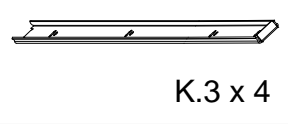
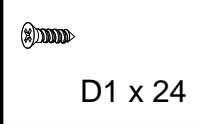

x 4

17



D1 x 4

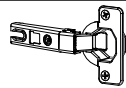

M.2 x 2

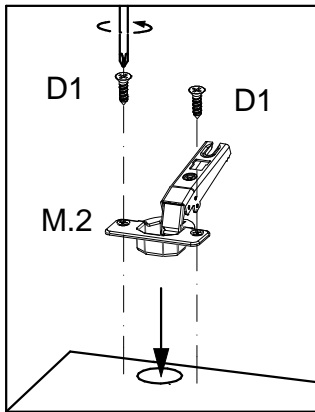
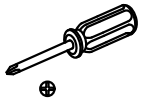

D1
M.2
D1

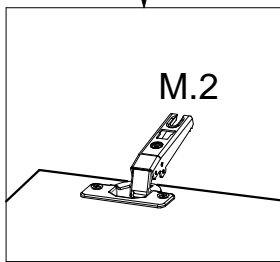

M.2

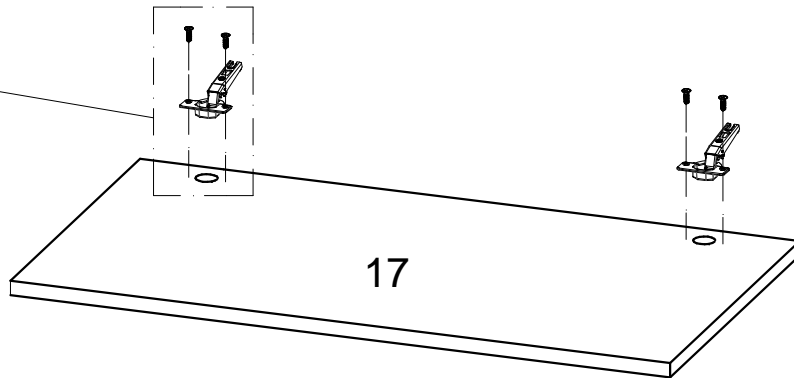

17

18

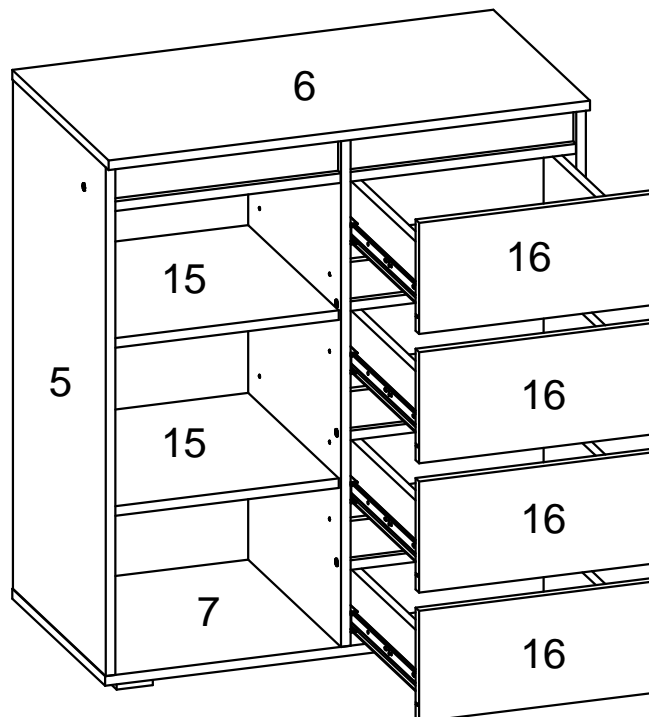

19

